

Gestaltung einer neuen Kunststoff-Filterbox mit Papieretikett dt./engl. und Schaumstoff-Einlage

Muster für Filtergrößen E 49, E 52, E 55, E 58, entworfen am 02.10.2009 und zuletzt überarbeitet am 26.01.2010 von Walter E. Schön

Maßstab 1:1

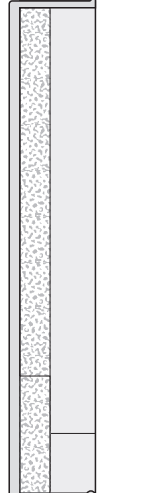
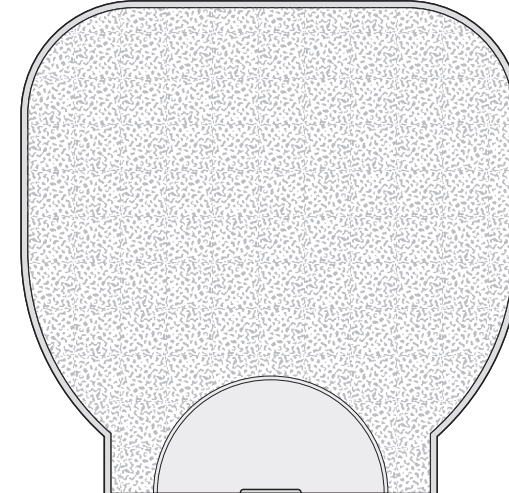
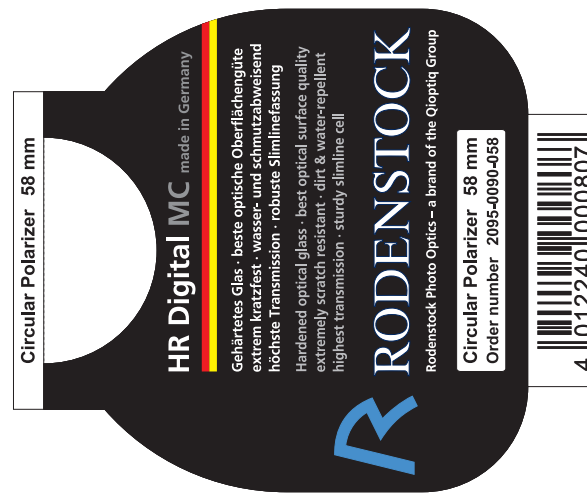
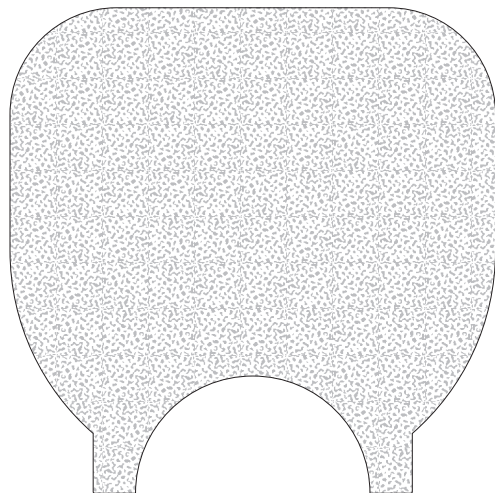
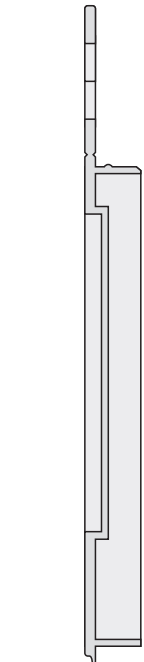
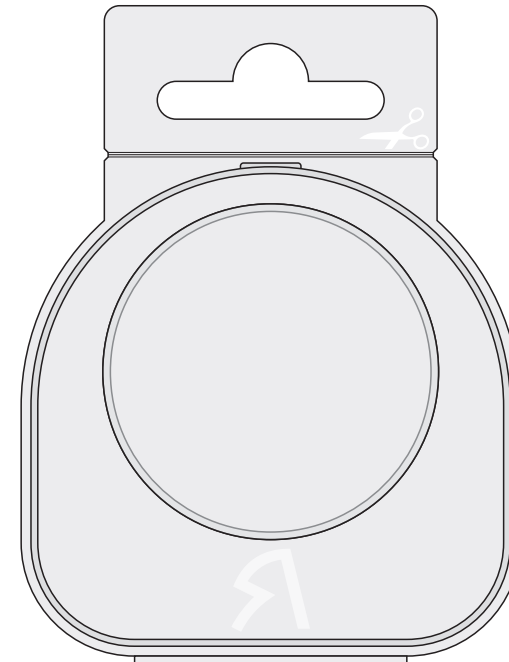
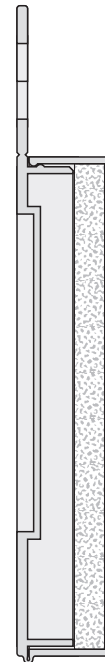
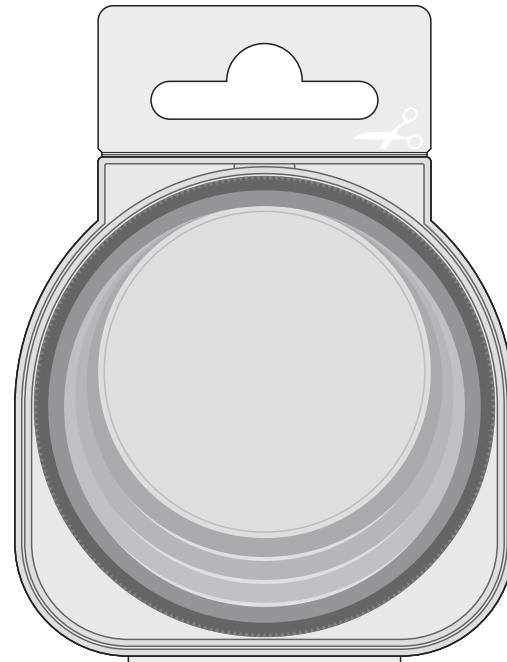

Maßstab 1,6:1

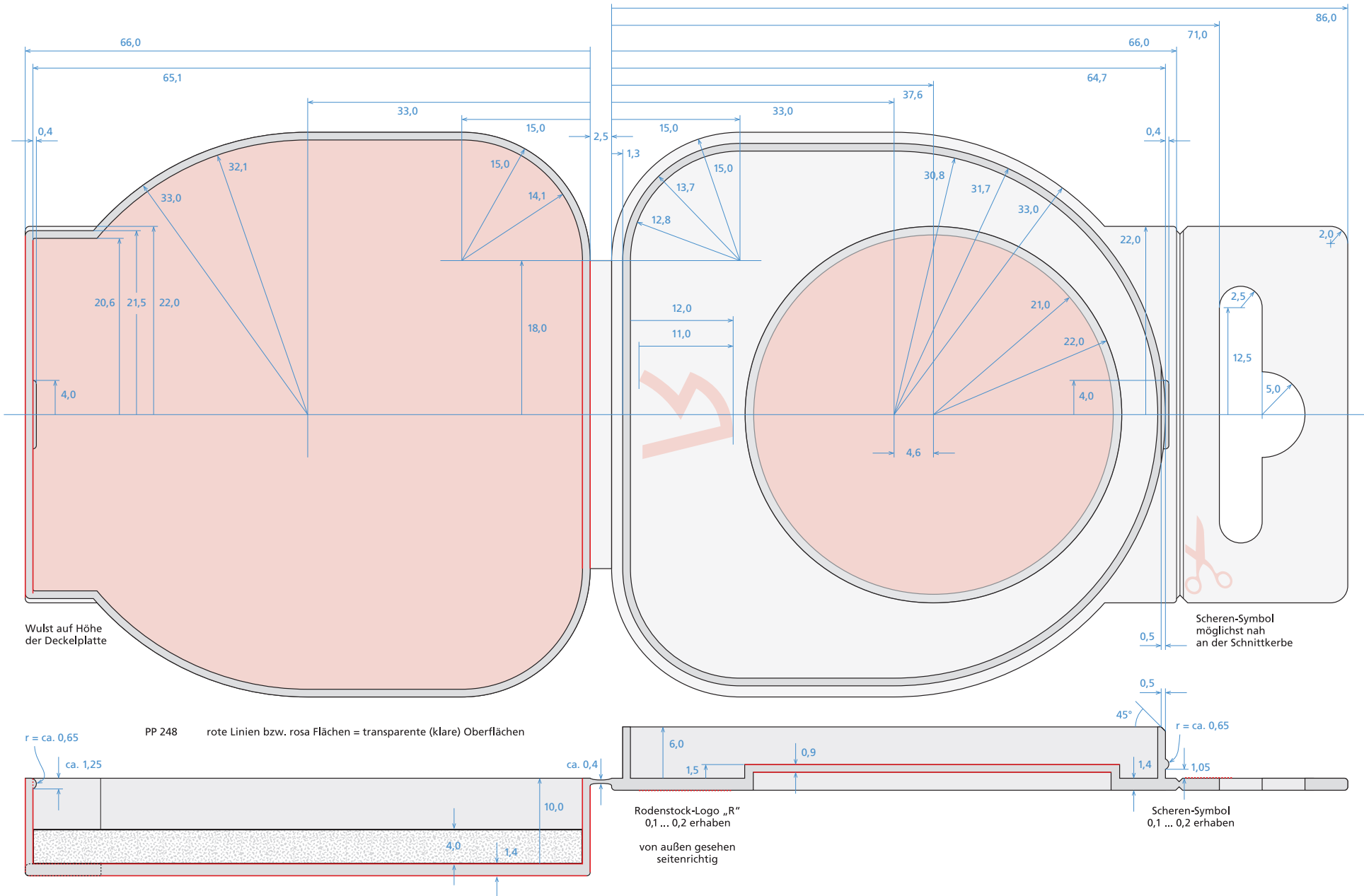

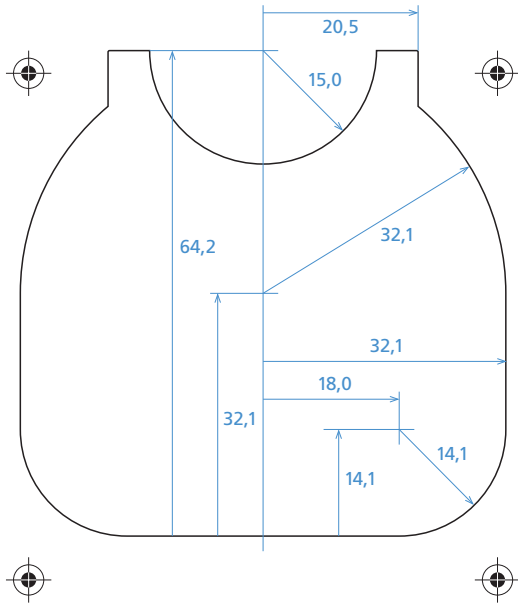

**Schaumstoff
4 mm dick**

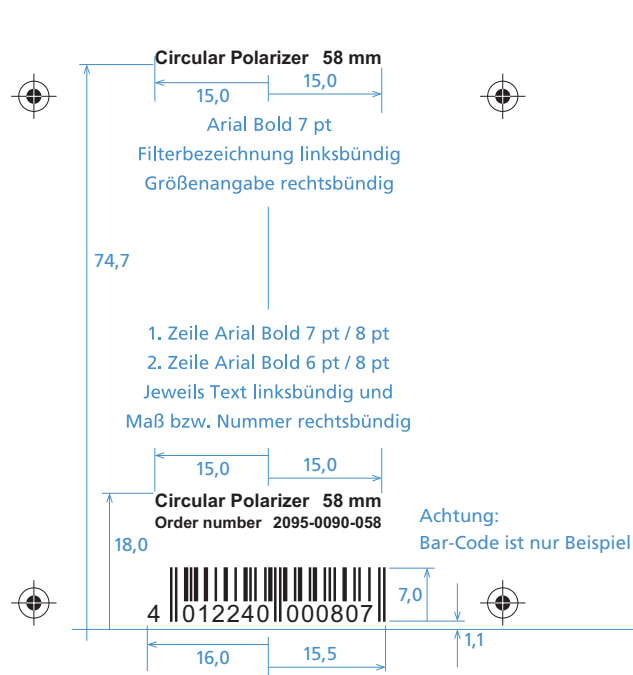

Druckvorlagen

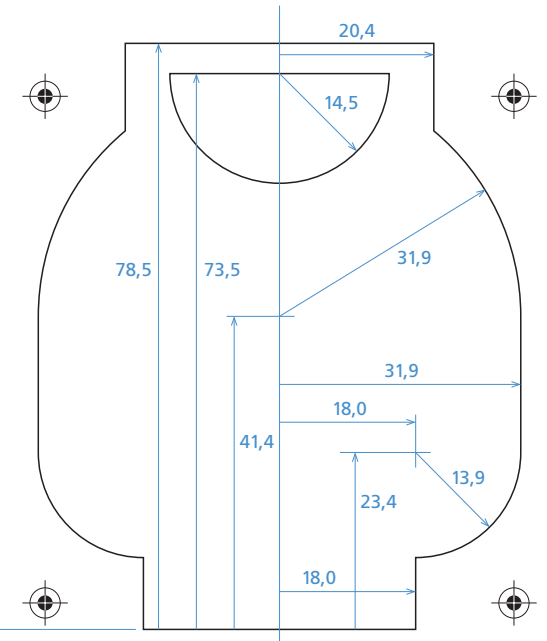

Stanzform

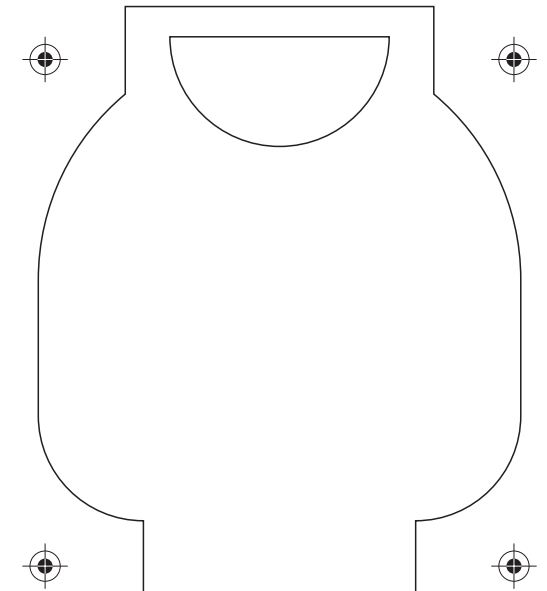
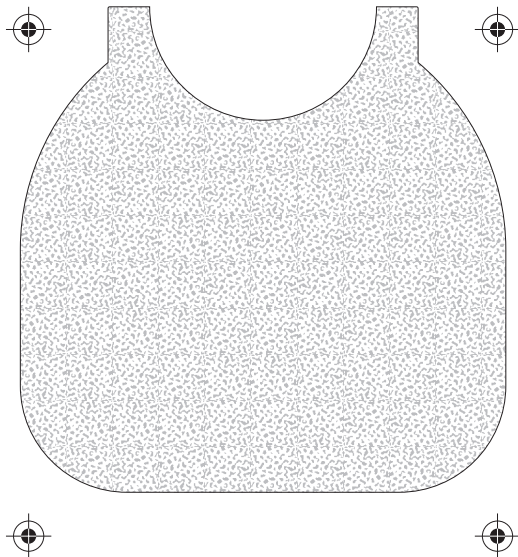

Circular Polarizer 58 mm

HR Digital MC made in Germany

Gehärtetes Glas · beste optische Oberflächengüte
extrem kratzfest · wasser- und schmutzabweisend
höchste Transmission · robuste Slimlinefassung

Hardened optical glass · best optical surface quality
extremely scratch resistant · dirt & water-repellent
highest transmission · sturdy slimline cell



RODENSTOCK

Rodenstock Photo Optics — a brand of the Qioptiq Group

Circular Polarizer 58 mm

Order number 1095-0090-058



4 012345 678901

UV Blocking Filter 58 mm

HR Digital MC made in Germany

Gehärtetes Glas · beste optische Oberflächengüte
extrem kratzfest · wasser- und schmutzabweisend
höchste Transmission · robuste Slimlinefassung

Hardened optical glass · best optical surface quality
extremely scratch resistant · dirt & water-repellent
highest transmission · sturdy slimline cell



RODENSTOCK

Rodenstock Photo Optics — a brand of the Qioptiq Group

UV Blocking Filter 58 mm

Order number 1095-0020-058



4 012345 098765

Scheren-Symbol für abzuschneidende Aufhänger-Lasche der neuen Kunststoff-Filterbox

Entworfen am 13.01.2010 und zuletzt überarbeitet am 20.01.2010 von Walter E. Schön

Maßstab 20:1

